

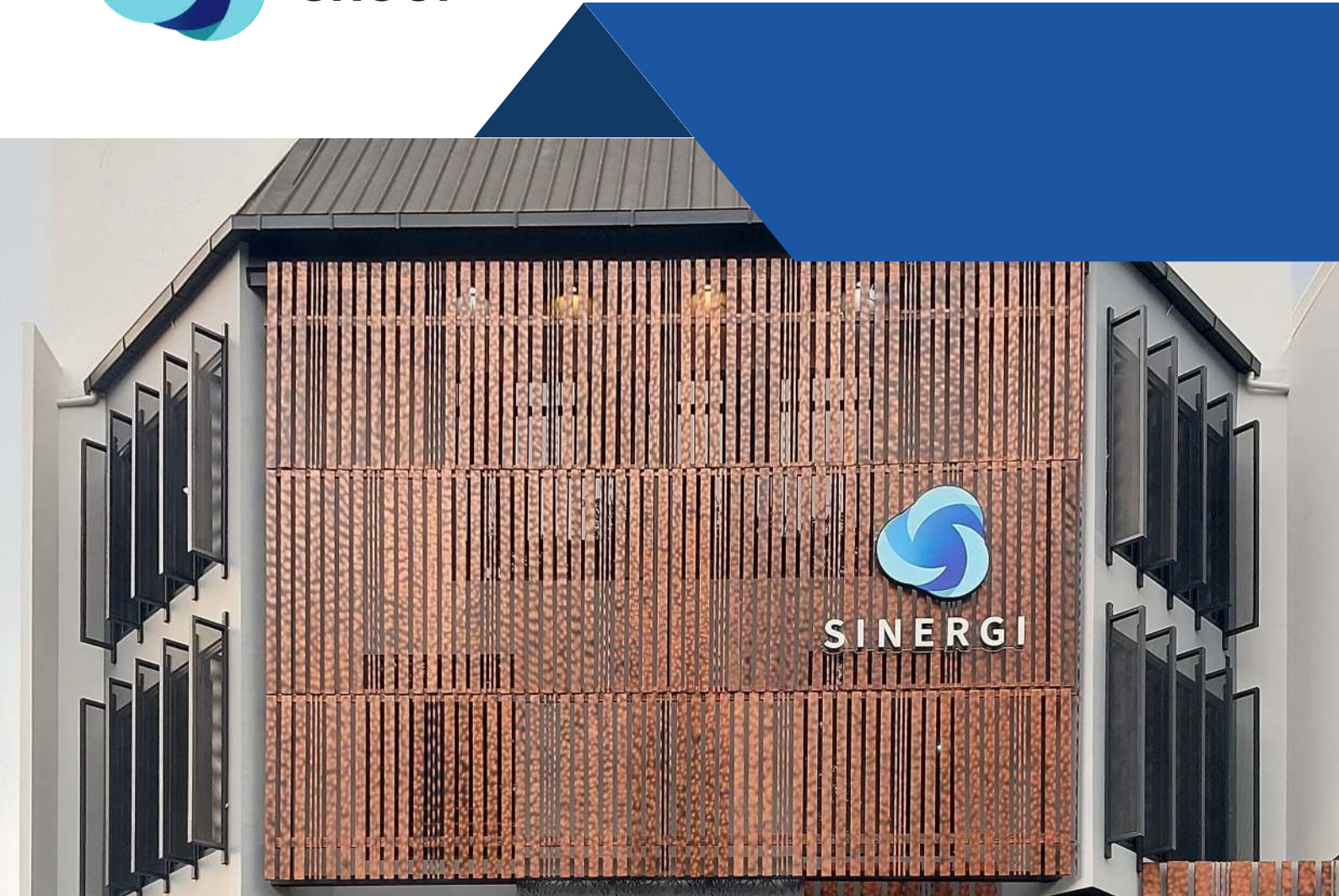

**SINERGI
GROUP**



Empowering Critical Infrastructure with Integrated Technology

COMPANY PROFILE 2026

www.sinergiteknoglobal.co.id

”

We are not bound by family ties,
but by a shared vision and purpose.



About Us



Andy Sjachrial
CEO of Sinergi
Group

Sinergi Group is a system integrator based in Indonesia, focused on delivering technology solutions for the nation's critical infrastructure. With experience in sectors such as airports, immigration, public sector, and industry, we provide system integration services, solution development, and operational support using the latest technologies.

Vision Mission Values



→ Vision

To be the leading technology partner in transforming industries critical infrastructure through smart, secure, and sustainable solutions.

→ Mission

- Achieving sustainable growth and profitability.
- Improving products and services with cutting-edge technology to exceed customer expectations.
- Committed to complete technology transfer.
- Operating with universal ethical principles and values.
- Fostering a nurturing work environment for team well-being and growth.
- Investing in talent development for company success.
- Actively contributing to societal and environmental well-being.
- Valuing each individual as essential assets, building a strong foundation with commitment and integrity.

→ Values

Honesty & Integrity

Commitment

Ownership

Never Stop Action

Positivity

Key Partners



Together with our partners, we strengthen our core capabilities in Airport Solutions, Border Control, ICT Infrastructure, Engineering, and Security Systems. We also expand into next services, delivering digital, data, IOT, and AI platform solutions that drive our clients' success and future-readiness.



Our Solutions

- Airport Solutions
 - Border Control
 - Passport Solutions
 - Two-way Radio Communication
 - Command Center
 - Security Systems
 - Banking Solution
-



Our Services

→ Application
Development

→ IT Consulting

→ Network & IT
Infrastructure

→ IOT & AI Solutions

→ Engineering

→ IT Service
Management

Airport Solutions

Airport Operation Control Center (AOCC)



The central hub for managing all airport operations.

This vital control center serves as the nerve center of the airport, where every operational system essential for the seamless daily functioning of the airport is monitored and managed.

Elevate airport's operational excellence!

Our Solution Partner



Solutions

AODB

Airport Operational Database

FIDS

Flight Information Display System

IB

Information Broker

RMS

Resource Management System

AMS

Airport Management System

A-CDM

Airport Collaborative Decision Making

Airport Solutions

Baggage Handling System (BHS)

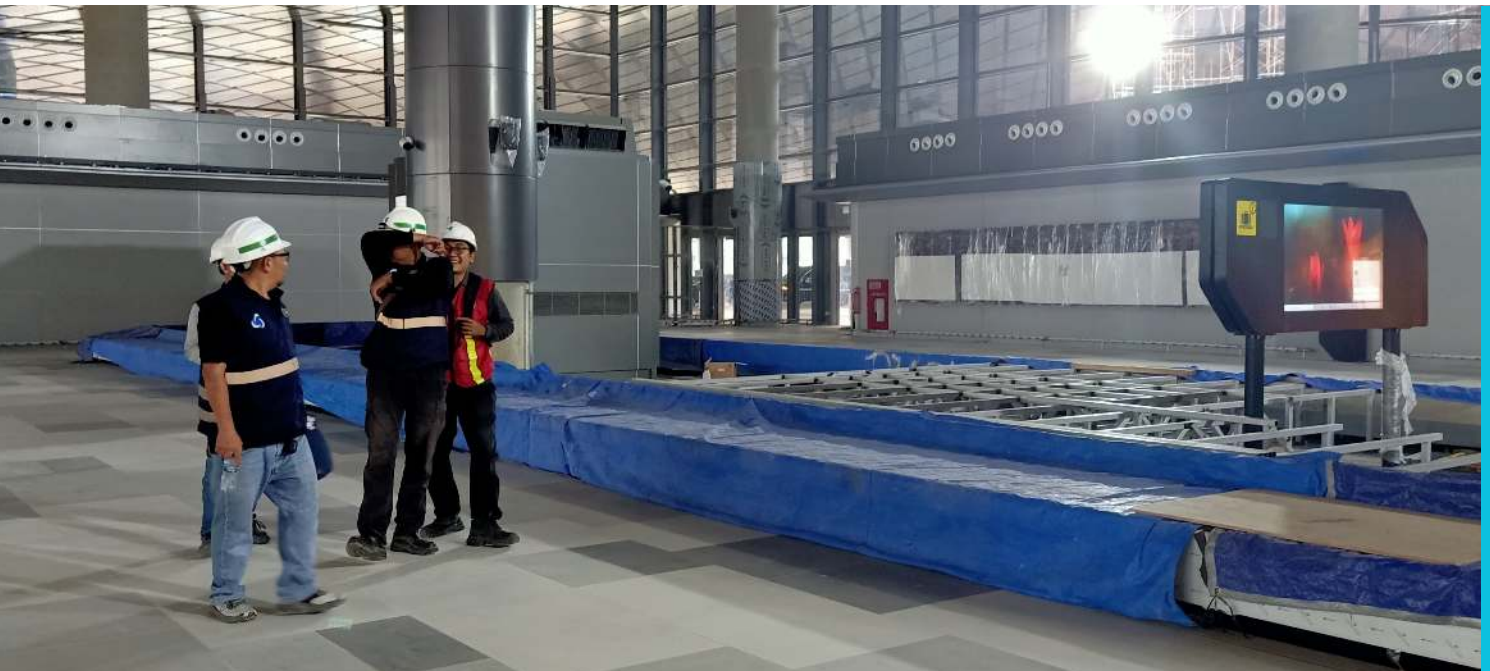

Smart, Secure, Seamless Baggage Movement

We provide integrated Baggage Handling System (BHS) solutions designed to enhance the efficiency, accuracy, and security of baggage operations in airports. Our system ensures that baggage is tracked, screened, sorted, and delivered on time — from check-in to loading, and from arrival to claim.

Whether for new airport terminals or upgrading existing systems, our solutions are built to support growing passenger volumes while minimizing human error and operational costs.

Our Solution Partner

VANDERLANDE  **BEUMERGROUP**



Autogate - Border Control

Enabling a smooth, safe and connected travel experience

We provide secure and privacy-compliant border control solutions that streamline operations for authorities while ensuring a smooth experience for travelers.

Security and privacy are fundamental to our approach

Our digital identity solutions streamline border processes, boost efficiency, and elevate both safety and traveler satisfaction.



Best in Class

We deliver leading-edge human-machine interaction and a fast, traveler-focused experience at border checkpoints.



Happy Flow

Our traveler-first approach ensures streamlined airport flows, boosting terminal capacity.



Realtime Monitoring

Our Digital Identity Management Platform empowers authorities with real-time visibility into traveler clearance activities.

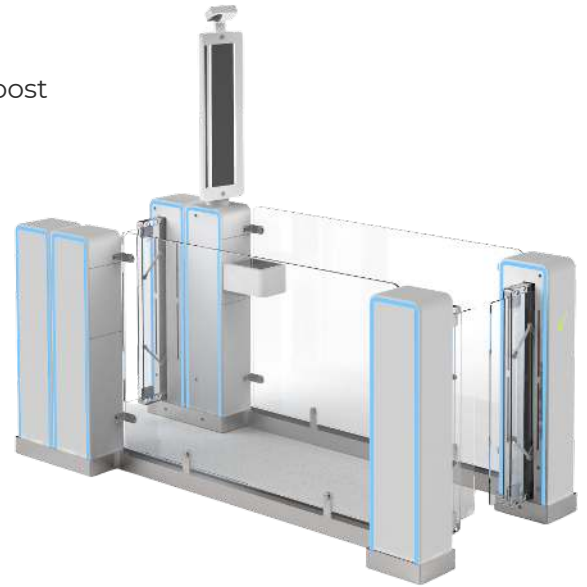

Passport Solutions



Seamless Identity Management with All-in-One Biometric Enrollment Technology (VDESK)

Features

- **ICAO Compliant Face Capture**
- **Different Configurations**
Desktop version and standing version, face only, face and fingerprint
- **Option of having its on PC**
ICAO Compliant automatic checks (ICAO 9303)
- **Using AMADEUS quality check algorithm**
- **Face matching available for citizen verification**

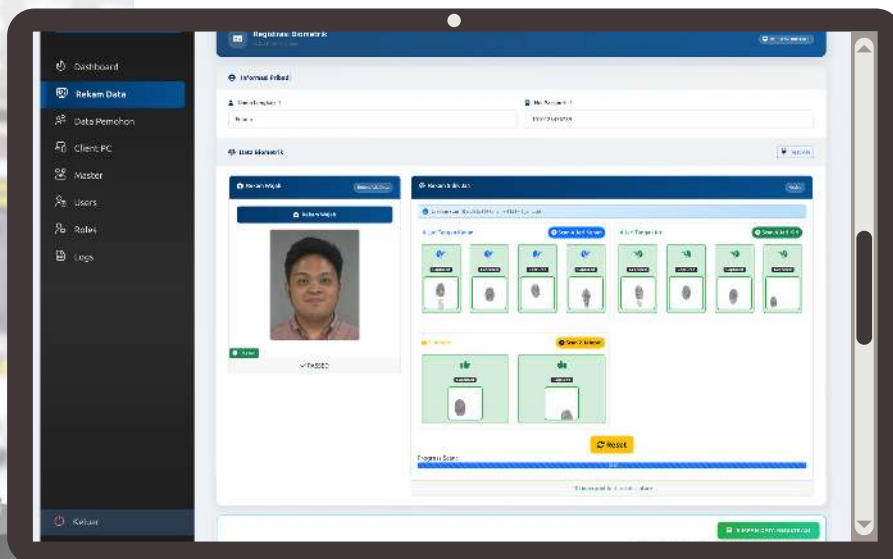

4/2/1 fingerprints scanner



2x single fingerprint scanners + signature pad

- ● ● VDESK software showed face capture and finger print in realtime

VDESK Application



Two-way Radio Solution

Robust, Secure, and Private Push-to-Talk Communication

We offer a wide range of two-way radios using DMR and TETRA technology to support mission-critical communication in public safety, emergency response, private security, utilities, and industrial operations. Intrinsically safe (IS) models are also available for use in hazardous environments.



Solutions

DMR Two-way Radios

DMR, Digital Mobile Radio, is a digital radio standard by ETSI, European Telecommunications Standards Institute



TETRA System

TETRA (Terrestrial Trunked Radio) is a professional mobile communication standard using TDMA technology, developed by ETSI for secure and reliable critical communications.



Our Solution Partner



Command Center

Creating Situational Awareness, Enhancing Operational Excellence



We deliver end-to-end Command Center solutions tailored for mission-critical environments such as Airport Operations Control Centers (AOCC), Security Operation Centers (SOC), and other government or enterprise command facilities.

Our services cover the entire lifecycle—from space planning and interior design to technology integration and dashboard development. We design intelligent environments that promote efficient decision-making, real-time monitoring, and seamless collaboration across departments.



Plan & Design



Construction
& Build



System
Integration



Dashboard
Development

Security systems

Sinergi Teknogloba Perakasa delivers sophisticated security system solutions designed to safeguard your organization's physical and digital assets with uncompromising precision. From advanced surveillance and intelligent access control to integrated threat detection, we provide end-to-end protection that ensures operational continuity and peace of mind. By merging cutting-edge hardware with smart software analytics, we empower your business with a proactive defense framework that is as resilient as it is reliable in an increasingly complex world.



Fraud Detection System (FDS)

Functionality System

Real-time Capabilities transaction Monitoring

Real-time in Decision Reaction

Real-time Capabilities Fraud Monitoring

Maximum Protection with Investigation & Analysis

Key Features of Fraud

Real-time Transaction Monitoring

Monitoring digital banking and e-channel platform activities live.

Customer Profiling

Analyzes behavioral patterns from account and card data.

Adaptive ML & Configurable workflow

Support dynamic rules, alert, and custom user actions.

Alert Monitoring & Analysis

Detects, Tracks, and investigates suspicious activities.

Interactive Dashboard

Instantly triggers alert via integrated notification engine.

Seamless Notification Integration

Instantly triggers via integrated notification engine.

Comprehensive Reporting

Support both on-demand and scheduled report generation.



Features

Behavior-Based Detection

Understand "normal" behavior to catch fraud instantly

ML-Powered Detection

Learns from behavior and patterns to detect fraud case

Multi-Channel Coverage

Full protection across all transaction types

Real-Time Risk Scoring

Full protection across all transaction types

Custom Rule Engine

Adapt to your institution's unique risk profile

Seamless Integration

Fast, secure API-based deployment with minimal disruption

Monitored Channel



ATM



Internet banking payment



Mobile & Internet banking



E-Commerce



POS

Risk Scoring & Flagging Threshold



Low risk (white)

Scores < 50; minimal intervention required.



Medium Risk (Grey)

Scores between 50-100; requires further investigation



High Risk (Black)

Scores > 100; immediate action necessary.



Application Development

Transform Your Ideas into Impactful Applications

We provide end-to-end application development tailored to your business goals. Our approach starts by understanding your needs, designing, building, and deploying solutions that integrate seamlessly with your existing digital infrastructure. With ongoing support and system reliability at the core, we ensure your applications continue to deliver value.



Understanding your needs

We help define your technology roadmap to identify the right solutions that align with your objectives.



End-to-End Application Lifecycle Support

Whether you're building from scratch or upgrading existing systems, we provide tailored solutions from planning to deployment, ensuring your applications are future-ready and scalable.



Modular Design

We build applications using component-based architecture to ensure flexibility and alignment with your business needs.



Seamless Delivery and Operations

Accelerate the development of secure, high-quality enterprise applications through an integrated approach to delivery and operations.



Agile and Secure by Design

Accelerate solution development with agile and DevSecOps practices ensuring speed, security, and faster time-to-market.

IT CONSULTING

Sinergi Teknogloba Perkasas serves as a strategic partner empowering businesses to navigate the complexities of the digital era through comprehensive IT consulting services. By fostering a powerful synergy between innovative technology and your core business objectives, we deliver scalable, secure, and future-ready solutions designed to drive sustainable growth. We are committed to transforming your technical challenges into competitive advantages, ensuring your organization remains resilient and ahead of the curve in an ever-evolving global landscape.



IT Service Mangement

Ensuring Reliability, Driving Performance

We offers end-to-end IT Service Management (ITSM) to maintain the health and performance of your IT systems and infrastructure. We apply ITIL best practices to ensure structured service delivery and continuous improvement.

Core IT Services



Problem Management



Incident Management



Corrective Maintenance

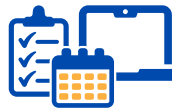

Preventive Maintenance



Performance Monitoring & Reporting



SLA Management

Our services are supported by an AI-powered service desk platform that enables faster response, proactive issue detection, and data-driven performance analysis, keeping your operations efficient, reliable, and future-ready.



IOT & AI Solutions

Tailored to Your Needs



Enhance your operational insight through Internet of Things (IoT) integration

Our IoT solutions enable data-driven analysis, anticipate future demands, and enhance operational efficiency for smarter business performance.

From building sensor and device infrastructure, integrating with existing systems, to developing intelligent analytics and dashboards — we ensure seamless execution. **Our solutions** enable real-time monitoring, automation, and data-driven decision-making, all within a secure and adaptable ecosystem.

IOT Solutions



**Smart Building
Smart City**



Smart Homes



**Smart
Manufacturing**



Smart Agriculture

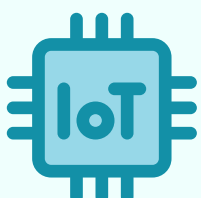

Transforming how we live,
work, and play.

Network & IT Infrastructure

Seamless Connectivity & Robust Networking Solutions



We provide end-to-end services to build and enhance robust IT infrastructure and networking systems. We support both greenfield designs and audits of existing environments to identify improvement areas and ensure optimal system performance.

Our Services

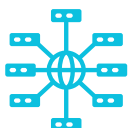

**Network Design
Architecture**

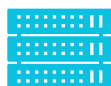

**Network
Installation**



**Network & IT Infrastructure
Management**

Engineering Services

Sinergi Teknogloba Perakasa provides high-end engineering services that transform complex technical requirements into robust and scalable digital architectures. Our team combines technical precision with innovative design to build high-performance systems and seamless integrations that optimize your operational efficiency. By focusing on reliability, security, and modern engineering standards, we ensure that every solution we build is not only resilient for today's demands but also adaptable to the technological advancements of tomorrow.



Project Portfolio

"Every project we deliver reflects our core values — from precise planning to innovative execution, we build with purpose."

Strategic
Implementation
Nurtured by
Excellence,
Reliability,
Growth, and
Innovation

Autogate

Border Control



**Directorate General of Immigration
Republic of Indonesia**

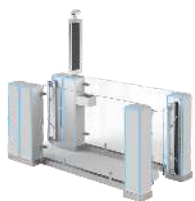
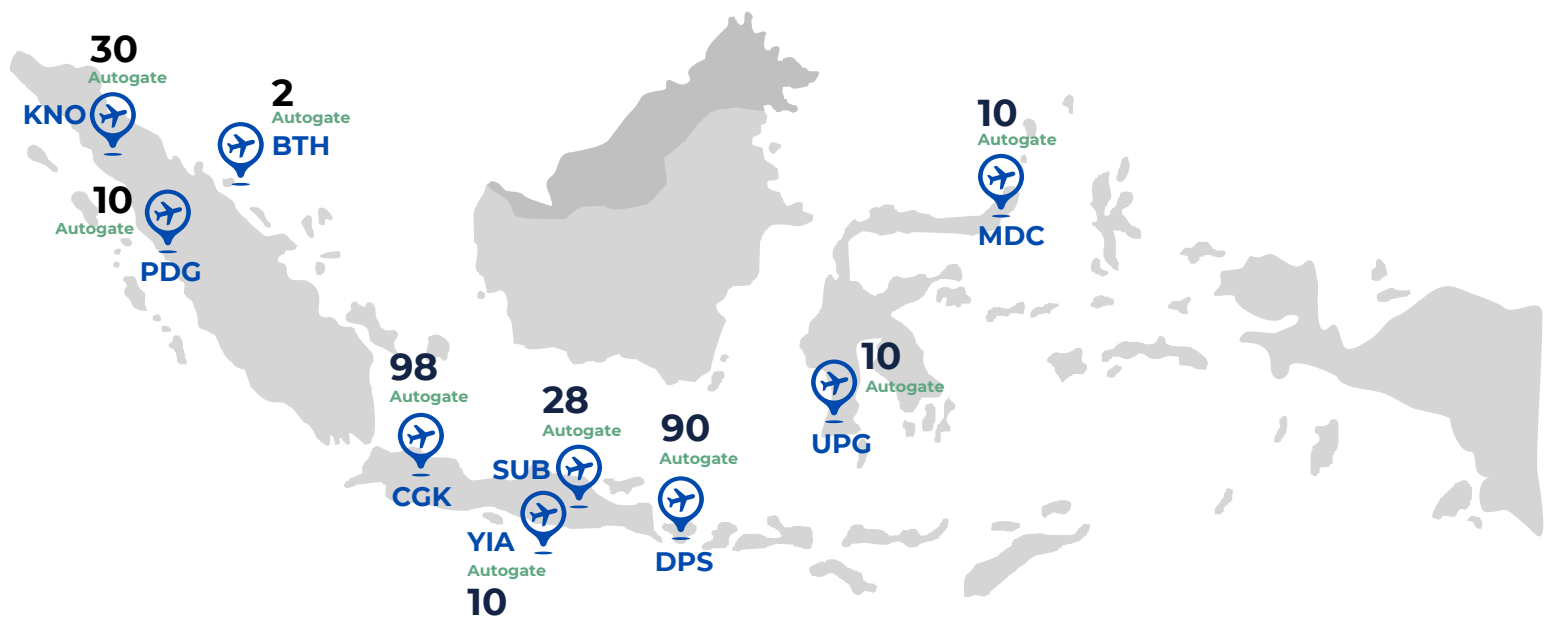

288
**Autogates
installed**

Autogate Project (2022 - 2025)

Sinergi successfully implemented Autogate systems at major Indonesian airports, enabling fast and secure immigration clearance. Seamless biometrics and passport authentication, the solution streamlines passenger flow while supporting border operations.

Security Operation Center (SOC)

Dhoho Airport - Kediri

Centralized Control, Enhanced Airport Security

Sinergi delivered a comprehensive Security Operation Center (SOC) solution for Dhoho International Airport, integrating surveillance, access control, and alarm monitoring into a centralized platform. This SOC enables real-time situational awareness and faster incident response, ensuring safety and operational continuity across the airport environment.

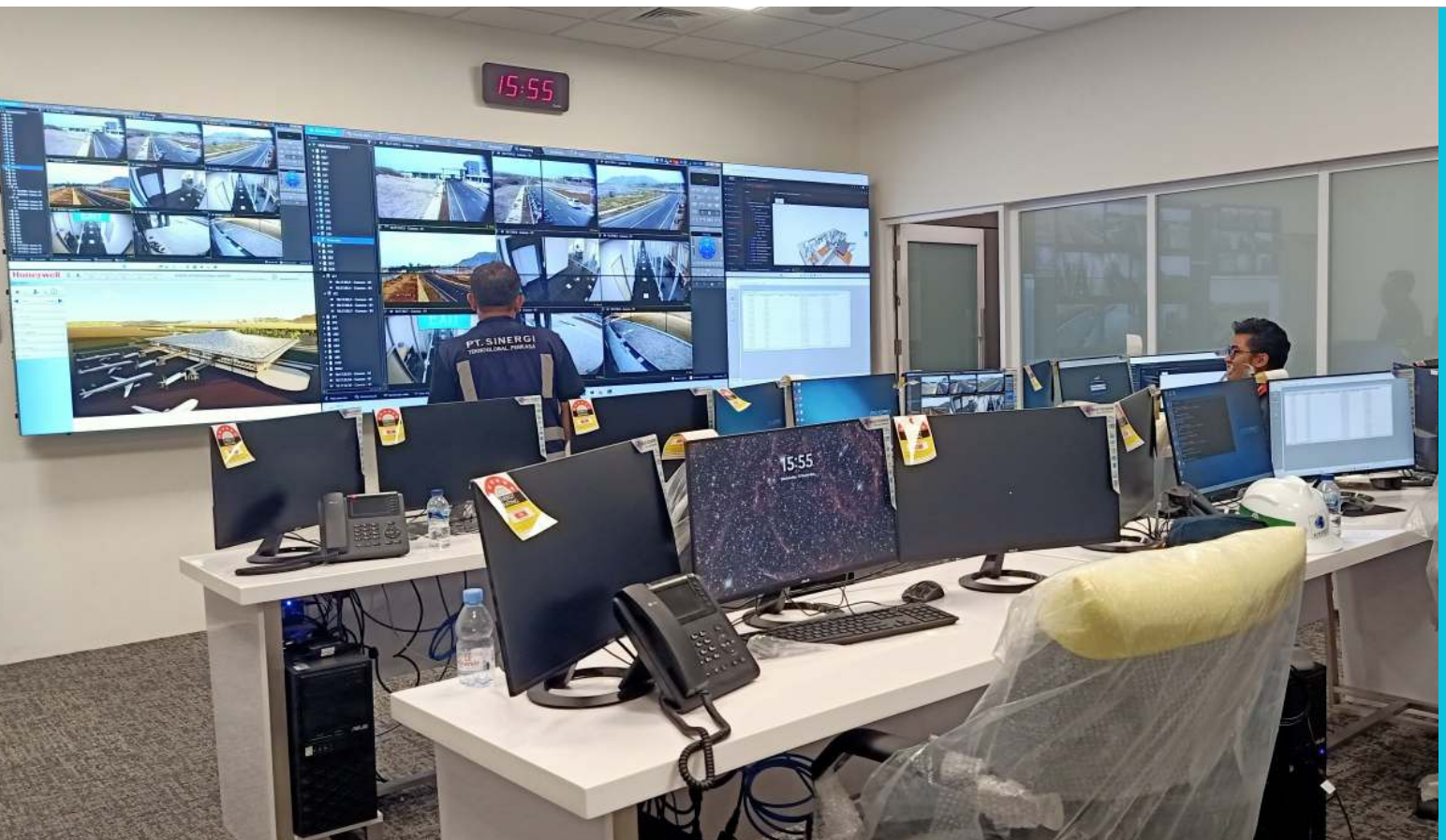

System Integration

CCTV | Video Management System | Access Control | Fire Alarm

Genetec AGIL Honeywell BOSCH

Financial Project

Proven Delivery Across Banking, Payment & Financial Ecosystem



1

BANK BTN

CRM system for centralized customer data and relationship management.



2

Bank Syariah Indonesia (BSI)

Real-time OLTP switching system for secure financial transaction processing.



3

Bank Mega

Fraud detection system with real-time monitoring and risk scoring.



4

Jalin Pembayaran Nusantara

Automated financial simulator for end-to-end payment transaction testing.



5

Bank NTB Syariah

Fraud monitoring platform to strengthen transaction security and compliance.



6

Bank BCA

ATM multivendor production system for centralized control and monitoring.



7

Netzme Kreasi Indonesia

Fraud detection for digital wallet transactions using behavioral analysis.



8

GDC Pay

Transaction fraud monitoring system for payment processing ecosystem.



9

Finnet Indonesia

Centralized financial service platform for multi-channel payment integration.

Our Customers





**SINERGI
GROUP**



Empowering Progress, Together

CONTACT US



Metland Puri, Blok F2 No 10 Kel.
Petir Kec. Cipondoh, Tangerang
Indonesia - 15146



(021) 38924038



adminsales@sinergiteknoglobal.co.id



www.sinergiteknoglobal.co.id